

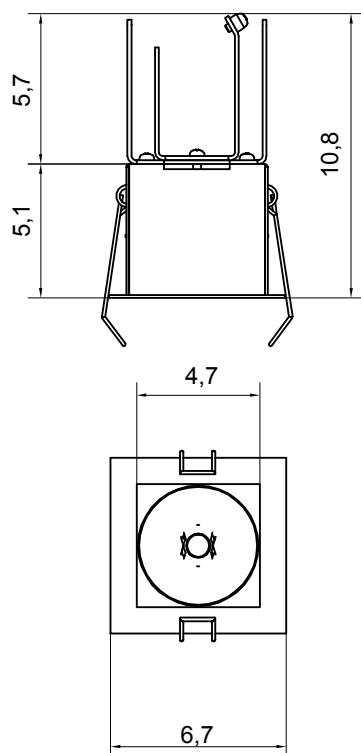

modello: model:	STAR MEDIUM 4		
codice: code:	6714		
design:	UT Egoluce		
anno - year:	2022		
tipologia: typology:	faretto mini trim da incasso mini trim recessed spotlight		
materiali: materials:	corpo in alluminio, riflettore in policarbonato metallizzato, schermo in vetro aluminum structure, metallized polycarbonate reflector, glass screen		
luce: light:	d'accento o diffusa accent or diffuse		
sorgente luminosa: light source:			
LED code	beams optic	LED color	
<i>/W</i>	<i>/24 /40 /60</i>	LED 8,91W 17,8V 500mA	1353lm 4000K
<i>/W/ST</i>	vetro satinato - <i>satin glass</i>	LED 8,91W 17,8V 500mA	1353lm 4000K
<i>/WW</i>	<i>/24 /40 /60</i>	LED 8,91W 17,8V 500mA	1303lm 3000K
<i>/WW/ST</i>	vetro satinato - <i>satin glass</i>	LED 8,91W 17,8V 500mA	1303lm 3000K
<i>/XW</i>	<i>/24 /40 /60</i>	LED 8,91W 17,8V 500mA	1244lm 2700K
<i>/XW/ST</i>	vetro satinato - <i>satin glass</i>	LED 8,91W 17,8V 500mA	1244lm 2700K
life	> 50.000 h		
step MacAdam	3		
Indice di Resa Cromatica: Color Rendering Index:	>80 CRI>90 su richiesta CRI>90 on request		
grado IP - IP grade:	40		
peso netto - net weight:	0,25 Kg		
finiture - finishes:	.01 bianco	.01 white	
	.02 nero	.02 black	
marcatura: marking:	CE		
simboli costruttivi: symbols:			

SOLO COLLEGAMENTO IN SERIE - ONLY SERIAL CONNECTION

Dimensioni - Dimensions



F 5,9 x 5,9 cm

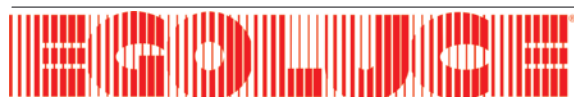

EGOLUCE s.r.l., via I.Newton 12 - 20016 Pero - Milano
telefono +39 02 339586.1 - fax. +39 02 3535112
e-mail: info@egoluce.com - http://www.egoluce.com

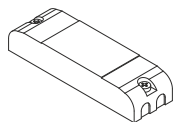
LED DRIVERS in corrente continua
LED DRIVERS constant current**0127****LED driver**
IN: 100 - 240V
OUT: 500 mA
1 COB LED

11,6 x 3,4 x 2 cm 4 cm

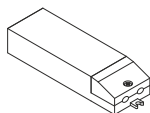
0147/COB**LED driver**
IN: 220 - 240V
OUT: 500 mA
1-2 COB LED

12,5 x 3,8 x 2,4 cm 4,2 cm

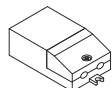
0149/COB**LED driver**
IN: 220 - 240V
OUT: 500 mA
1 COB LED

7,6 x 3,9 x 2,2 cm 4,2 cm

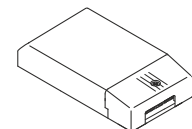
0169/50**Multipower LED driver**IN: 220 - 240V
OUT: 500mA
1-3 COB LED

13 x 7,5 x 3 cm 8,5 cm

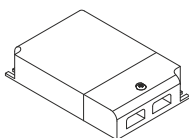
DRIVERS DIMMERABILI in corrente continua
DIMMABLE LED DRIVERS constant current**0129 Dimmer LED**
Multipower dimmable driverIN: 110 - 240V
OUT: 500 mA
1-2 COB LED

10,5 x 7 x 2,2 cm 7,2 cm SELV

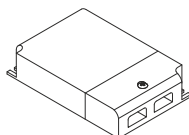
0129/DALI Dimmer LED**Multipower dimmable driver**IN: 110 - 240V
OUT: 500 mA
1-2 COB LED

10,5 x 7 x 2,2 cm 7,2 cm SELV

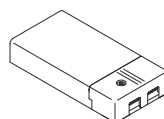
0141/DALI**LED driver**IN: 110 - 240V
OUT: 500 mA
1-2 COB LED

11,1 x 5,2 x 2,5 cm 5,5 cm

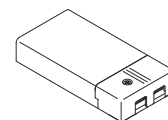
0141/DIM**LED driver**IN: 110 - 240V
OUT: 500 mA,
1-2 COB LED

Versione PUSH non sincronizzabile - PUSH version not synchronizable

11,1 x 5,2 x 2,5 cm 5,5 cm

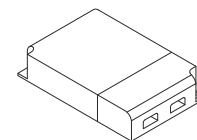
0145 Dimmer LED Maxi**Multipower dimmable driver**IN: 110 - 240V
OUT: 500 mA
1-3 COB LED

12,3 x 8 x 2,2 cm 8,4 cm SELV

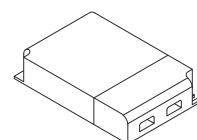
0145/DALI Dimmer LED Maxi**Multipower dimmable driver**IN: 110 - 240V
OUT: 500 mA
1-3 COB LED12,3 x 8 x 2,2 cm
 8,4 cm SELV **0133**Cavo di sincronizzazione per dimmer LED
Synchronization cable for dimmer LED
(art. 0129 - art. 0129/DALI - art. 0145 - art. 0145/DALI)

L 150 cm

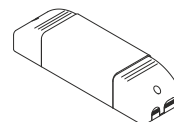
0726/DIM**LED dimmer**TAGLIO DI FASE (IGBT-TRIAC, TRAILING EDGE-LEADING EDGE)
PHASE CUT-OFF (IGBT-TRIAC, TRAILING EDGE-LEADING EDGE)
IN: 220 - 240V
OUT: 24V - 20W
500 mA
1-2 COB LED

16,5 x 4,5 x 3,5 cm 5,6 cm IGBT-TRIAC SELV

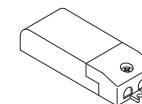
0734/DIM**LED dimmer**Alimentatori elettronici dimmerabili (IGBT-TRIAC) in corrente continua
Direct current dimmable (TRAILING EDGE-LEADING EDGE) electronic driversIN: 220 - 240V
OUT: 500 mA
1 COB LED

8,7 x 3,8 x 2,1 cm 4,2 cm IGBT-TRIAC SELV

UNITA' DI EMERGENZA LED
LED EMERGENCY UNIT**0115/EM****LED Emergency Unit**

Kit Inverter + Battery + LED indicator

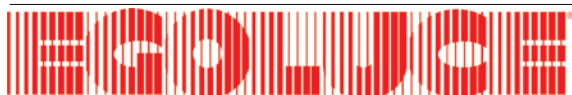
15,5 x 5,2 x 2,5 cm + 80 cm + 13,5 x 4,5 x 2,3 cmEGOLUCE s.r.l., via I.Newton 12 - 20016 Pero - Milano
telefono +39 02 339586.1 - fax. +39 02 3535112
e-mail: info@egoluce.com - http://www.egoluce.com